

## 60V P-Ch Power MOSFET

### Feature

- ◇ High Speed Power Switching, Logic Level
- ◇ Enhanced Avalanche Ruggedness
- ◇ Lead Free, Halogen Free

$V_{DS}$		-60	V
$R_{DS(on),typ}$	$V_{GS}=10V$	125	$m\Omega$
$R_{DS(on),typ}$	$V_{GS}=4.5V$	160	$m\Omega$
$I_D$ (Silicon Limited)		-2.2	A

### Application

- ◇ Load Switches
- ◇ Hard Switching and High Speed Circuit
- ◇ BLDC Motor

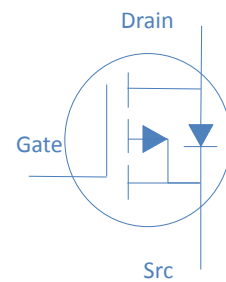
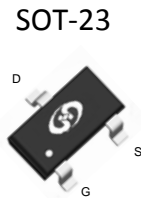

Part Number	Package	Marking
HTJ1K5P06	SOT-23	28

### Absolute Maximum Ratings at $T_j=25^\circ\text{C}$ (unless otherwise specified)

Parameter	Symbol	Conditions	Value	Unit
Continuous Drain Current (Silicon Limited)	$I_D$	$T_A=25^\circ\text{C}$	-2.2	A
		$T_A=70^\circ\text{C}$	-1.4	
Drain to Source Voltage	$V_{DS}$	-	-60	V
Gate to Source Voltage	$V_{GS}$	-	$\pm 20$	V
Pulsed Drain Current	$I_{DM}$	-	-8.8	A
Power Dissipation	$P_D$	$T_A=25^\circ\text{C}$	1.25	W
Operating and Storage Temperature	$T_J, T_{stg}$	-	-55 to 150	$^\circ\text{C}$

### Absolute Maximum Ratings

Parameter	Symbol	Max	Unit
Thermal Resistance Junction-Ambient	$R_{\theta JA}$	100	$^\circ\text{C/W}$

**Electrical Characteristics at  $T_j=25^\circ\text{C}$  (unless otherwise specified)**
**Static Characteristics**

Parameter	Symbol	Conditions	Value			Unit
			min	typ	max	
Drain to Source Breakdown Voltage	$V_{(BR)DSS}$	$V_{GS}=0V, I_D=-250\mu A$	-60	-	-	V
Gate Threshold Voltage	$V_{GS(th)}$	$V_{GS}=V_{DS}, I_D=-250\mu A$	-1.0	-1.70	-3.0	
Zero Gate Voltage Drain Current	$I_{DSS}$	$V_{GS}=0V, V_{DS}=-24V, T_j=25^\circ\text{C}$	-	-	-1	$\mu A$
		$V_{GS}=0V, V_{DS}=-20V, T_j=125^\circ\text{C}$	-	-	-10	
Gate to Source Leakage Current	$I_{GSS}$	$V_{GS}=\pm 20V, V_{DS}=0V$	-	-	$\pm 100$	nA
Drain to Source on Resistance	$R_{DS(on)}$	$V_{GS}=-10V, I_D=-2A$	-	125	150	m $\Omega$
		$V_{GS}=-4.5V, I_D=-1.5A$	-	160	200	
Transconductance	$g_{fs}$	$V_{DS}=-5V, I_D=-2A$	-	3	-	S

**Dynamic Characteristics**

Input Capacitance	$C_{iss}$	$V_{GS}=0V, V_{DS}=-30V, f=1\text{MHz}$	-	1032	-	pF
Output Capacitance	$C_{oss}$		-	66	-	
Reverse Transfer Capacitance	$C_{rss}$		-	48	-	
Total Gate Charge	$Q_g$	$V_{DD}=-10V, I_D=-2A, V_{GS}=-10V$	-	12.3	-	nC
Gate to Source Charge	$Q_{gs}$		-	1.6	-	
Gate to Drain (Miller) Charge	$Q_{gd}$		-	2.4	-	
Turn on Delay Time	$t_{d(on)}$	$V_{DD}=-10V, I_D=-1A, V_{GS}=-10V, R_G=6\Omega,$	-	12	-	ns
Rise time	$t_r$		-	20	-	
Turn off Delay Time	$t_{d(off)}$		-	20	-	
Fall Time	$t_f$		-	25	-	

**Reverse Diode Characteristics**

Diode Forward Voltage	$V_{SD}$	$V_{GS}=0V, I_F=-2A$	-		-1.2	V
-----------------------	----------	----------------------	---	--	------	---

Fig 1. Typical Output Characteristics

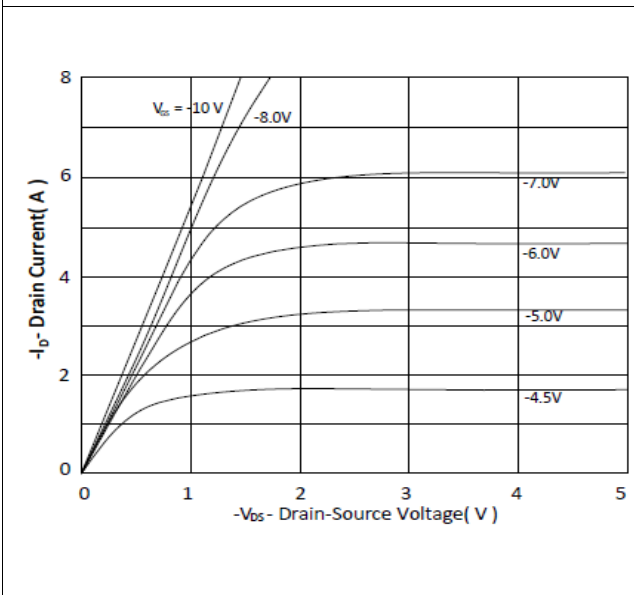

Figure 2. On-Resistance vs. Gate-Source Voltage

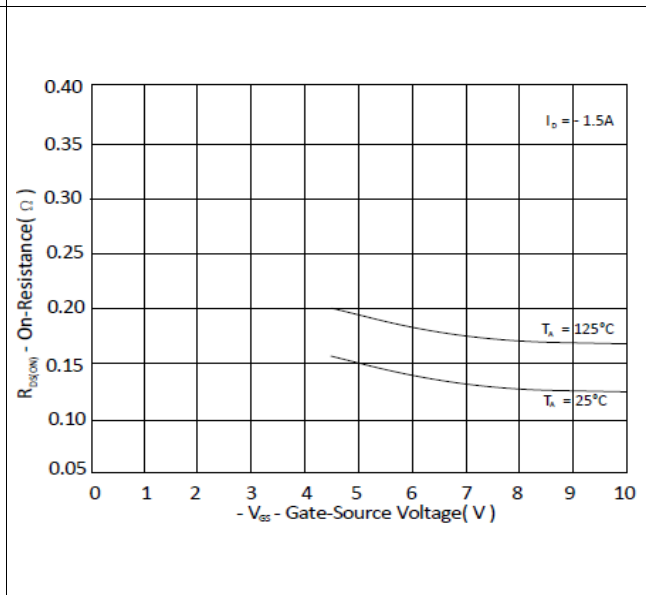

Figure 3. On-Resistance vs. Drain Current and Gate Voltage

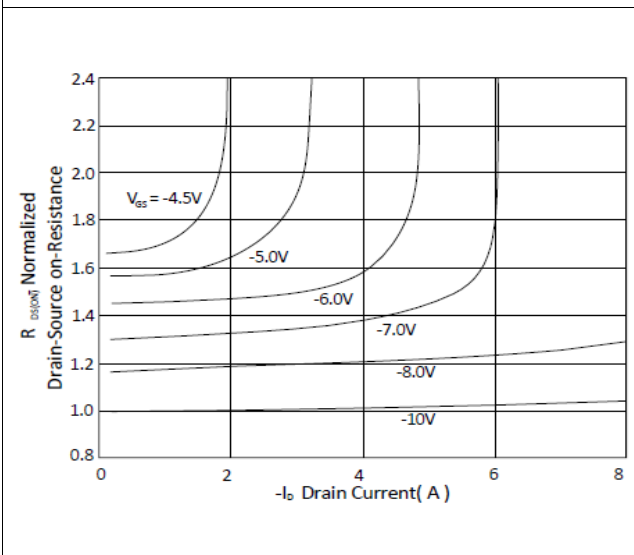

Figure 4. Normalized On-Resistance vs. Junction Temperature

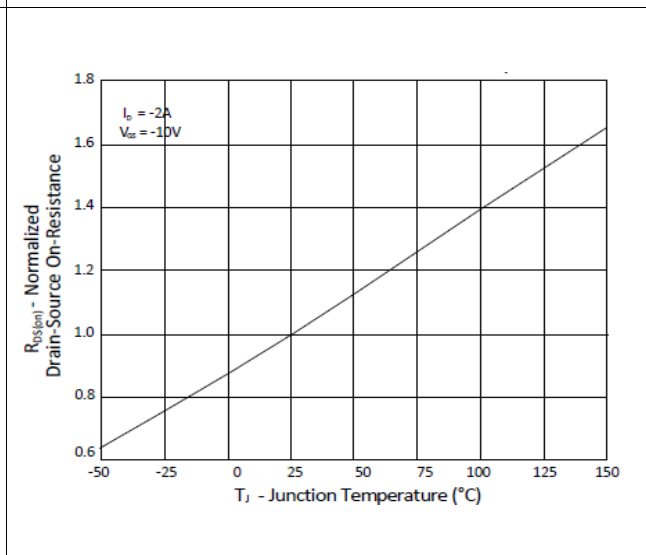

Figure 5. Typical Transfer Characteristics

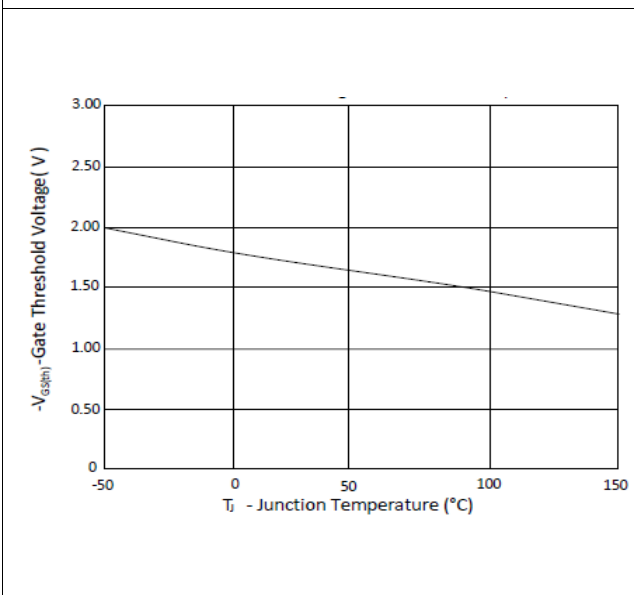

Figure 6. Typical Source-Drain Diode Forward Voltage

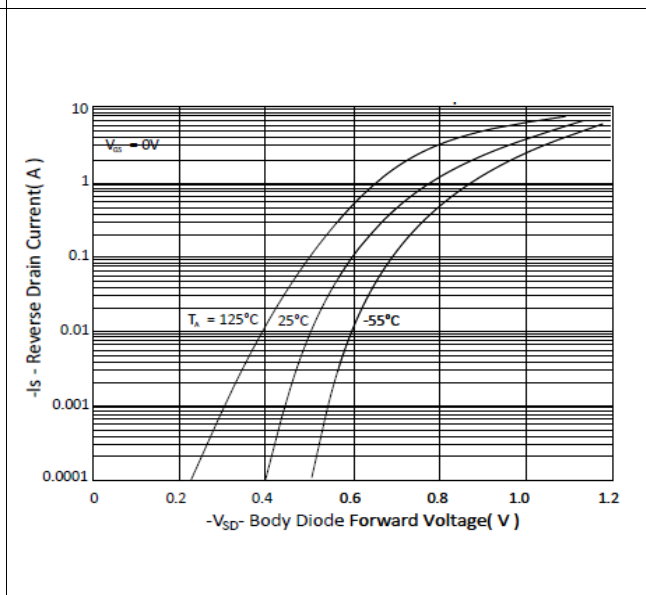

Figure 7. Typical Gate-Charge vs. Gate-to-Source Voltage

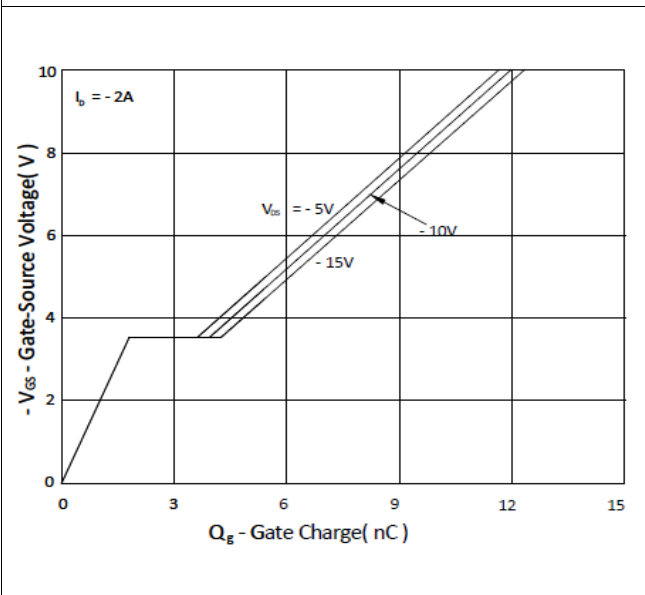

Figure 8. Typical Capacitance vs. Drain-to-Source Voltage

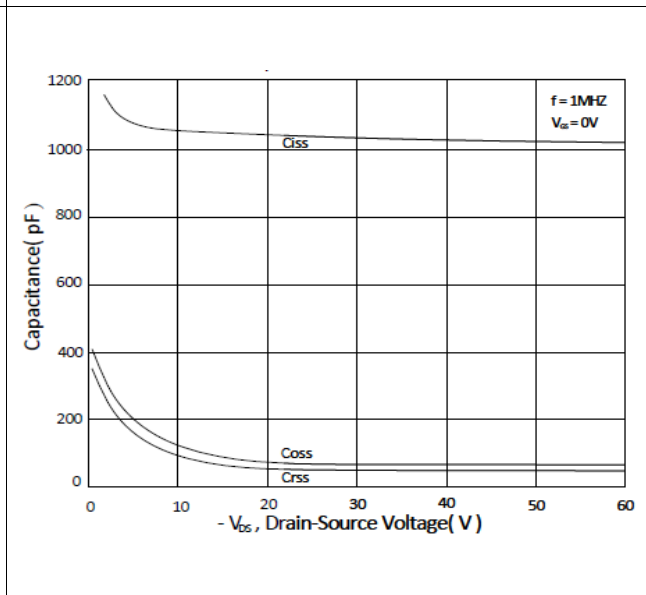

Figure 9. Maximum Safe Operating Area

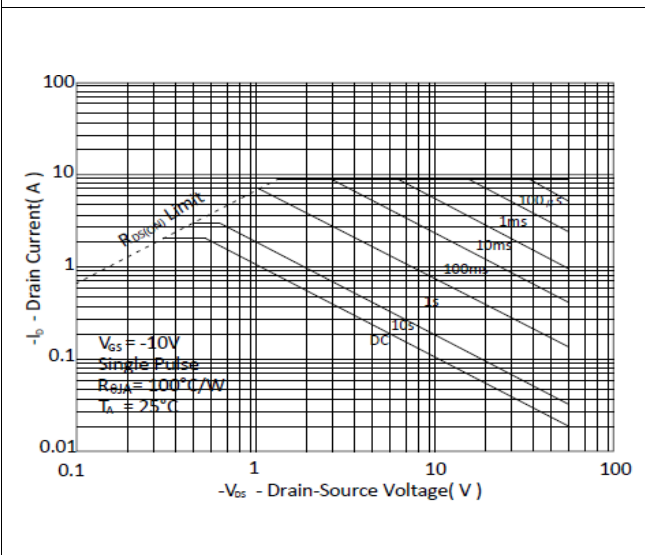

Figure 10. Single Pulse Maximum Power Dissipation

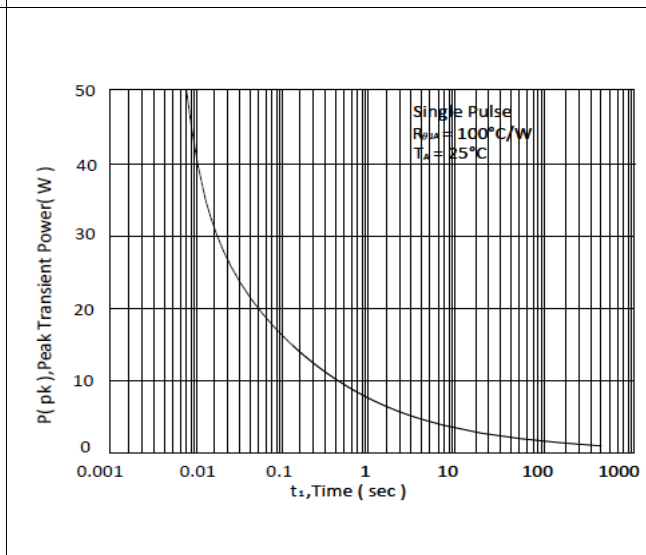
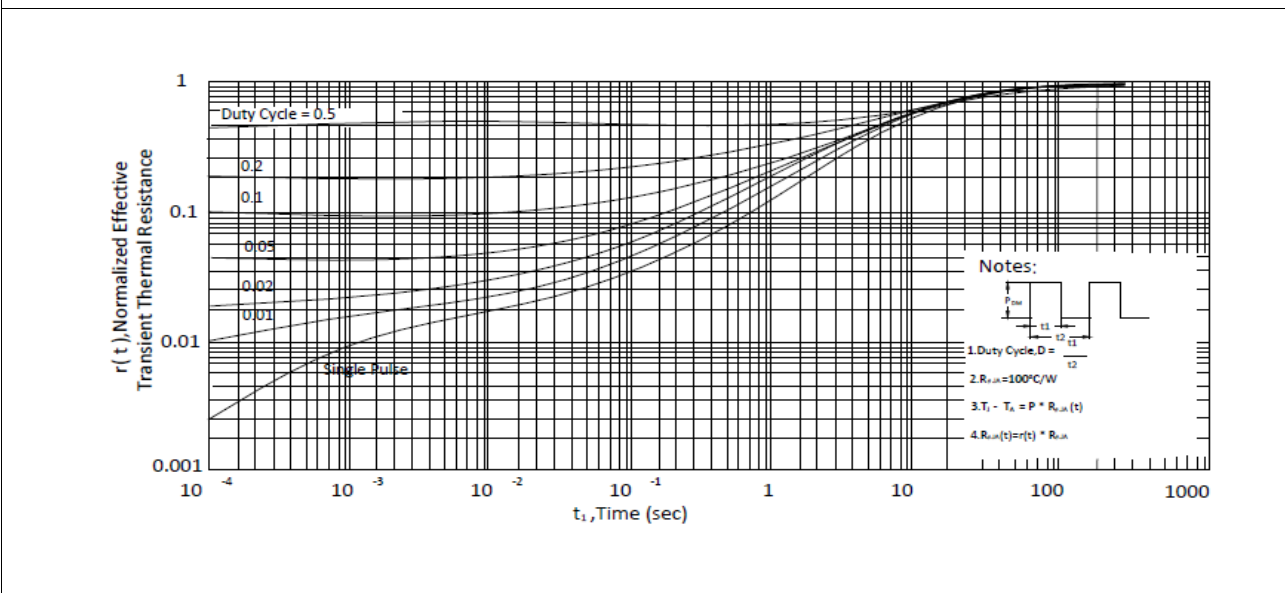
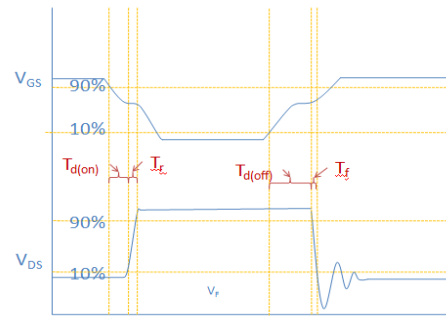
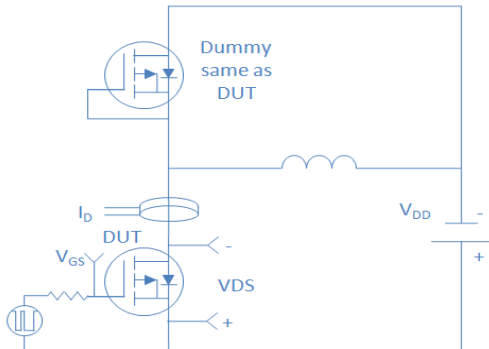

Figure 11. Normalized Maximum Transient Thermal Impedance, Junction-to-Ambient



Inductive switching Test



Gate Charge Test

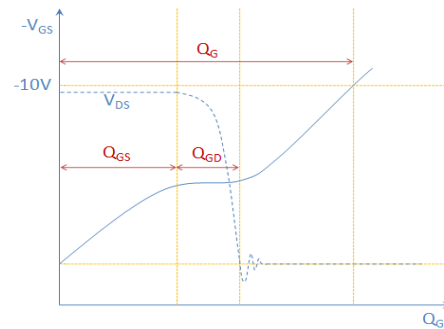
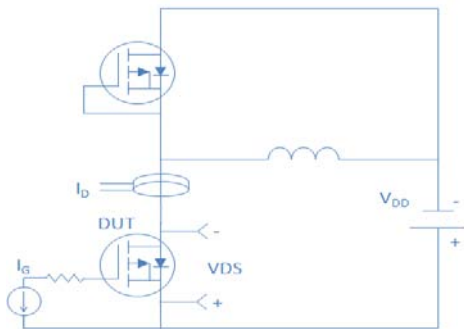

Uclamped Inductive Switching (UIS) Test

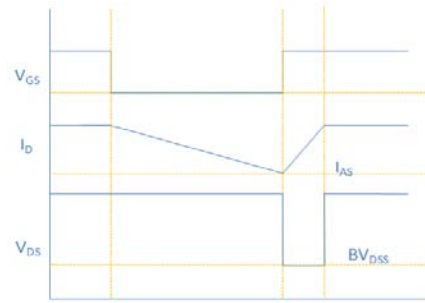
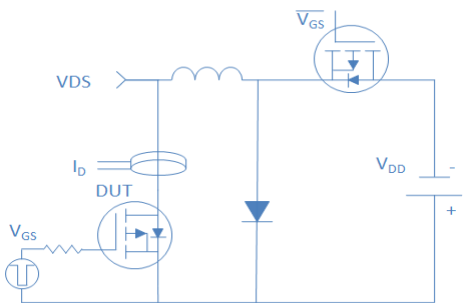

Diode Recovery Test

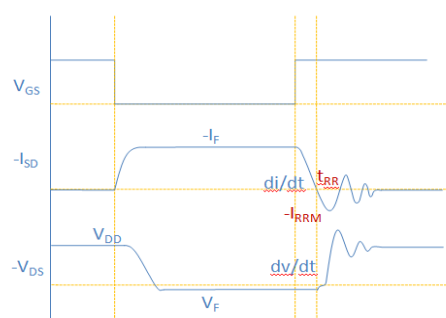
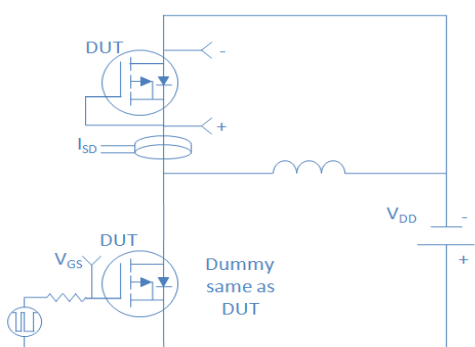

Package Outline

SOT-23, 3leads

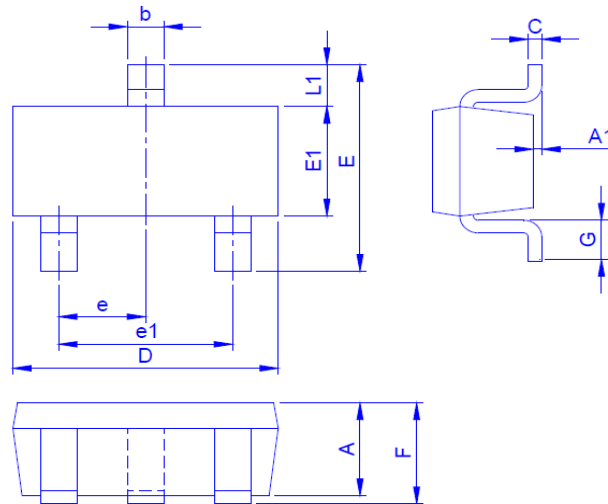

Dimension in mm

Dimension	A	A1	A2	b	C	D	E	E1	e	e1	F	G	L1
Min.	0.7	0		0.35	0.1	2.8	2.6	1.5	0.9		0.8	0.3	0.55
Typ.						2.9	2.8	1.6	0.95	1.9			
Max.	1.12	0.1		0.5	0.2	3	3	1.7	1		1.2	0.6	0.65